

# Zurcon® Scraper DA24 & Venting Version



---

Double-acting

---

**Material:**

Zurcon®

---







## ■ Zurcon® Scraper DA24



### ■ Description

Zurcon® DA24 is a double-acting thermoplastic polyurethane scraper for severe operating conditions and heavy attack of dirt.

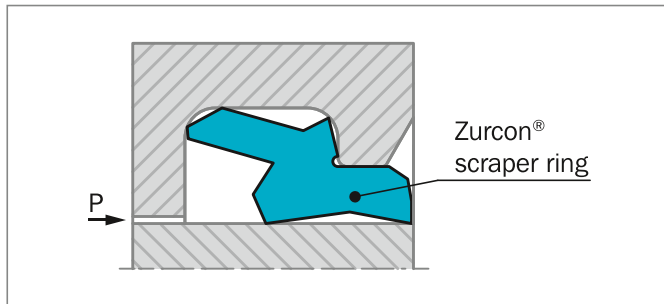

Figure 188: Scraper DA24: Standard Version

A new improved design available now in two different versions has been recently developed by Trelleborg Sealing Solutions to enhance the overall performances.

The special design of the inward-facing sealing lip contributes to an optimum contact pressure resulting in a very high scraper effect of the residual oil film thanks to the sharp, knife cut, scraping lip.

The outer scraper lip leans against the housing. This ensures an optimum sealing force and further it prevents the ingress of dirt and water across the groove bottom. Also in case of high level of external contamination and dirt or rod eccentricity under side load the scraper effect remains stable. The improved design reduces the friction with less heat generated and a longer service life.

The new design of DA24 is now available in two versions: standard and venting.

DA24 is produced in Zurcon®, the Trelleborg Sealing Solutions proprietary thermoplastic polyurethane material specially developed for sealing applications. This provides long service life under harsh working conditions and resistance against installation damage

### ADVANTAGES

- Very good scraper effect of the outward lip
- Very good sealing effect due to a trimmed inner sealing lip: Provides optimum contact pressure for efficient sealing and wiping of residual oil film
- Reliable at side steering of the piston rod
- Sturdy and wear-resistant
- Simple installation
- Advanced friction characteristics
- Limited heat generation extending service life
- Stability in the groove securing function
- Robust outer scraper lip supported by a housing recess, it ensures a high contact force on the rod

### VENTING VERSION FEATURE

In some situations when there is pressure build-up behind the scraper, the scraper can be pushed out of the groove causing total sealing system failure.

Zurcon® Scraper DA24 Venting Version has axial holes through the section which operate as pressure relief valves, allowing oil to be released in the case of overpressure.

Once the pressure is build-up the outer lip is temporarily activated through the axial holes and the pressure is released avoiding system failure. With improved stability in the groove the Zurcon® Scraper DA24 Venting Version becomes one of the most efficient scrapers available on the market.

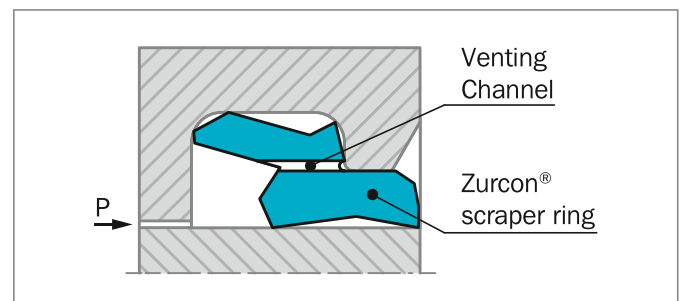
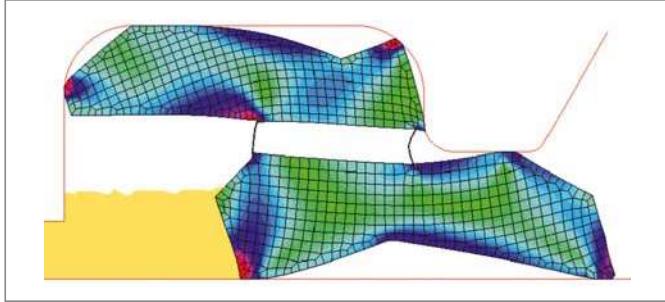

Figure 189: Scraper DA24: Venting Version



## METHOD OF OPERATION FOR VENTING VERSION



1. Pressurized oil flows through holes in the profile at the top of the scraping lip.

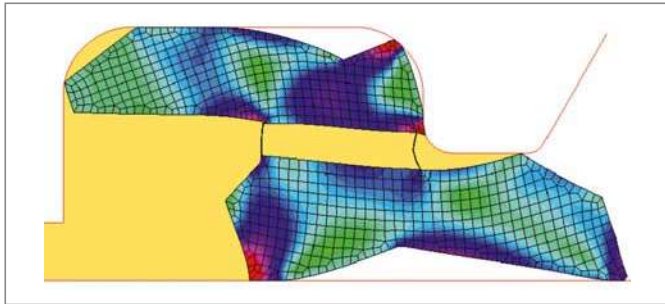

2. The scraping lip is pressed to the rod during pressure build-up.

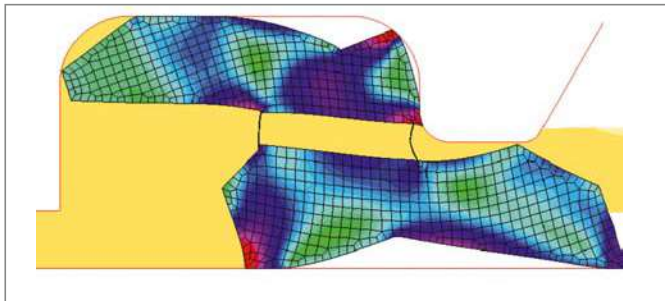

3. A gap opens up between scraping lip and housing at a certain pressure level.

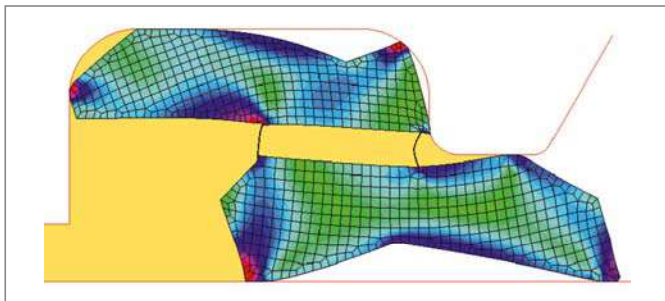

4. The oil is released and pressure is relieved.

## APPLICATION EXAMPLES

The scraper DA24 is especially suitable for application in:

- Construction machinery
- Agriculture- and forestry machinery
- Mobile hydraulic
- High attack of dirt
- Side steering of piston rod

## OPERATING CONDITIONS

<b>Pressure:</b>	standard version: max. 5 MPa venting version: max. 2 MPa
<b>Velocity:</b>	Up to 1 m/s at high strokes and higher speed, please contact your local Trelleborg Sealing Solutions company
<b>Temperature:</b>	-35 °C to +100 °C
<b>Media:</b>	Hydraulic fluids based on mineral oil

## MATERIALS – STANDARD APPLICATION:

The scraper DA24 consists of Zurcon® polyurethane material with excellent wear and extrusion resistance and low deformation under load.

Special Polyurethane: Zurcon® Z201 92 Shore A  
Set reference: Z201  
Color: Turquoise

## PREMIUM MATERIALS – HYDROLYSIS RESISTANCE:

Zurcon® Z24 Premium polyurethane

Set reference: Z24

The Zurcon® polyurethane has high abrasion resistance, a low compression set, high extrusion resistance and a wide temperature range.

## IMPORTANT NOTE

The above data are maximum values and cannot be used at the same time, e.g. the maximum operating speed depends on material type, pressure, temperature and gap value. Temperature range also depends on media.



## ■ Installation Recommendation

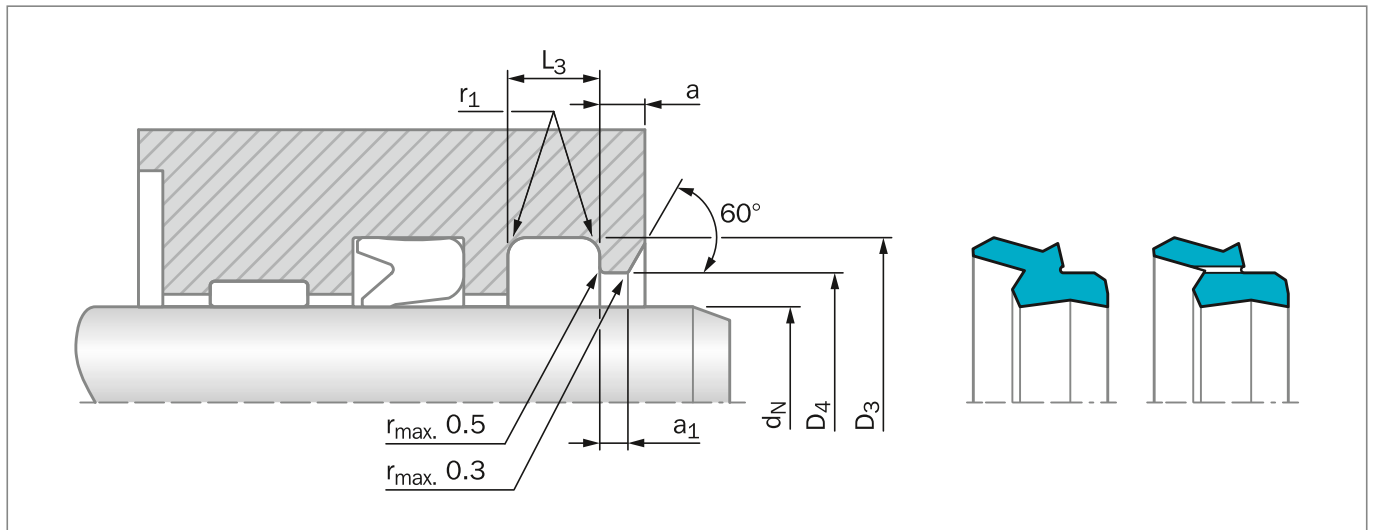

Figure 190: Installation Drawing

**Table 173: Preferred Series / Order No.**

Rod Diameter	Groove Diameter	Groove Width	Radius	Bore Diameter	Step Width	Step Width	TSS Article No. Standard Version
$d_N$ f8/h9	$D_3$ H9	$L_3$ +0.2	$r_1$ max.	$D_4$ H9	$a$ min.	$a_1$ min.	
45.0	53.8	6.3	1.2	49.4	3.2	2.0	WD2410450
50.0	58.8	6.3	1.2	54.4	3.2	2.0	WD2410500
56.0	64.8	6.3	1.2	60.4	3.2	2.0	WD2410560
60.0	68.8	6.3	1.2	64.4	3.2	2.0	WD2410600
70.0	82.2	8.1	1.6	76.0	4.0	2.5	WD2410700
75.0	87.2	8.1	1.6	81.0	4.0	2.5	WD2410750
80.0	92.2	8.1	1.6	86.0	4.0	2.5	WD2410800
85.0	97.2	8.1	1.6	91.0	4.0	2.5	WD2410850
90.0	102.2	8.1	1.6	96.0	4.0	2.5	WD2410900
95.0	107.2	8.1	1.6	101.0	4.0	2.5	WD2410950
100.0	112.2	8.1	1.6	106.0	4.0	2.5	WD2411000
105.0	117.2	8.1	1.6	111.0	4.0	2.5	WD2411050
110.0	122.2	8.1	1.6	116.0	4.0	2.5	WD2411100
115.0	127.2	8.1	1.6	121.0	4.0	2.5	WD2411150
125.0	137.2	8.1	1.6	131.0	4.0	2.5	WD2411250
140.0	156.0	9.5	2.0	148.0	5.0	3.0	WD2411400
150.0	166.0	9.5	2.0	158.0	5.0	3.0	WD2411500
160.0	176.0	9.5	2.0	168.0	5.0	3.0	WD2411600
170.0	186.0	9.5	2.0	178.0	5.0	3.0	WD2411700
180.0	196.0	9.5	2.0	188.0	5.0	3.0	WD2411800



Rod Diameter	Groove Diameter	Groove Width	Radius	Bore Diameter	Step Width	Step Width	TSS Article No. Standard Version
$d_N$ f8/h9	$D_3$ H9	$L_3$ +0.2	$r_1$ max.	$D_4$ H9	$a$ min.	$a_1$ min.	
200.0	216.0	9.5	2.0	208.0	5.0	3.0	WD2412000
220.0	236.0	9.5	2.0	228.0	5.0	3.0	WD2412200
240.0	256.0	9.5	2.0	248.0	5.0	3.0	WD2412400
260.0	276.0	9.5	2.0	268.0	5.0	3.0	WD2412600
280.0	296.0	9.5	2.0	288.0	5.0	3.0	WD2412800
290.0	306.0	9.5	2.0	298.0	5.0	3.0	WD2412900

Other dimensions on request

### ORDERING EXAMPLE

Standard Version:

<b>Rod Diameter:</b>	$d_N = 50$ mm
<b>Groove Diameter:</b>	$D_3 = 58.8$ mm
<b>Groove Width:</b>	$L_3 = 6.3$ mm
<b>TSS Article No.:</b>	WD2410500 from Table 173
<b>Material:</b>	Standard material Z201

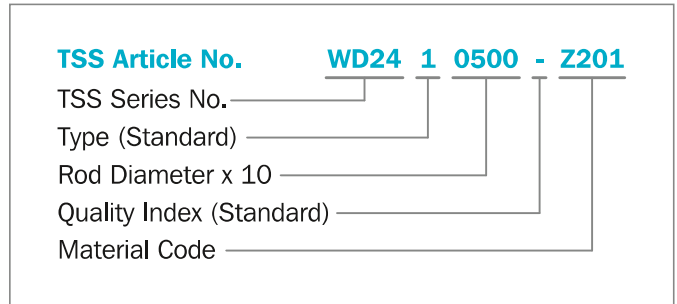

Venting Version:

<b>Rod Diameter:</b>	$d_N = 140$ mm
<b>Groove Diameter:</b>	$D_3 = 156$ mm
<b>Groove Width:</b>	$L_3 = 9.5$ mm
<b>TSS Article No.:</b>	WD24H1400
<b>Material:</b>	Standard material Z201

